



Model 375XLB

Theft Prevention Reduced Pressure Principle Assembly

Application

To help deter theft a durable black UV stabilized fusion epoxy coating is applied to the exterior bronze surfaces of the assembly. Ideal for use where Lead-Free* valves are required. Designed for installation on potable water lines to protect against both backsiphonage and backpressure of contaminated water into the potable water supply. Assembly shall provide protection where a potential health hazard exists.

Standards Compliance

- ASSE® Listed 1013
- IAPMO® Listed
- CSA® Certified B64.4
- AWWA compliant C511
- NSF® Listed-Standard 61, Annex G*
- UL® Classified (less shut-off valves only, 3/4" - 2")
- C-UL® Classified (less shut-off valves only, 3/4" - 2")
- Approved by the Foundation for Cross Connection Control and Hydraulic Research at the University of Southern California

Meets the requirements of NSF/ANSI 61
 *(0.25% MAX. WEIGHTED AVERAGE LEAD CONTENT)

Materials

Housing	Reinforced Nylon, FDA approved
Fasteners	Stainless Steel, 300 Series
Elastomers	Silicone (FDA Approved) Buna Nitrile (FDA Approved)
Internals	Delrin, Nylon
Springs	Stainless Steel, 300 series
Ball Valves	Low Lead Cast Bronze, ASTM B 584
Struts	Stainless Steel, 300 Series
Coating	FDA Approved Fusion Epoxy

Features

Sizes:	1/2", 3/4", 1", 1-1/4", 1-1/2", 2"
Maximum working water pressure	175 PSI
Maximum working water temperature	180°F
Hydrostatic test pressure	350 PSI
End connections	Threaded FNPT ANSI B1.20.1

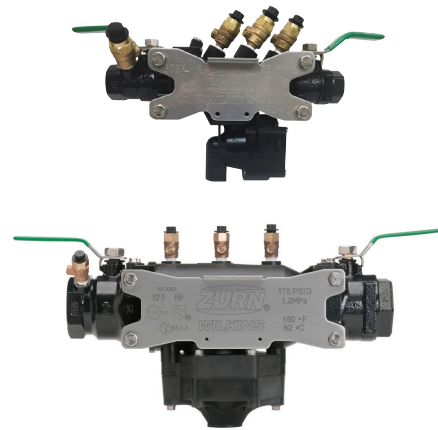

LEAD FREE



C



NSF/ANSI 61

Options

(Suffixes can be combined)

- with full port QT ball valves (standard)
- FT - with integral male 45° flare SAE test fitting
- AG - with air gap
- BOF - with Blow out/Flush fitting

Accessories

- Repair kits
- Thermal expansion tank (Mdl. XT)
- Soft seated check valve (Mdl. 40XL2)
- Shock arrester (Model 1250XL)
- QT-SET Quick Test Fitting Set
- Blow out / Flush fitting (RK34-375BOF, RK1-375BOF or RK114-350-375BOF)

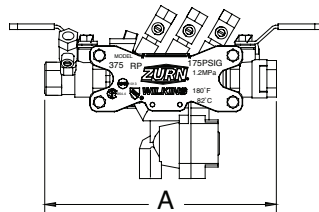
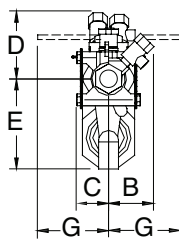

(1/2" - 1")

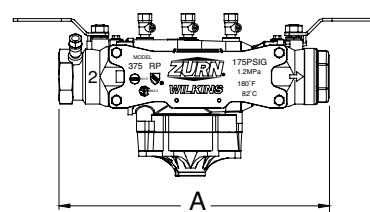

(1-1/4" - 2")

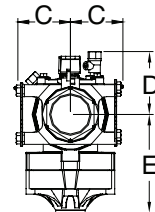

Dimensions & Weights (do not include pkg.)

MODEL 375XLB SIZE		DIMENSIONS (approximate)												WEIGHT	
		A		B		C		D		E		G		WITH BALL VALVES	
in.	mm	in.	mm	in.	mm	in.	mm	in.	mm	in.	mm	in.	mm	lbs.	kg
1/2	20	8 7/8	225	1 15/16	49	1 5/8	41	2 15/16	75	3 7/8	98	3	76	5.7	2.6
3/4	20	8 7/8	225	1 15/16	49	1 5/8	41	2 15/16	75	3 7/8	98	3	76	5.7	2.6
1	25	11 3/16	284	2 1/4	57	2 1/4	57	3 7/16	87	4	102	4	102	9.7	4.4
1-1/4	32	14 7/8	378	3 3/8	86	3 3/8	86	3 3/4	95	5 3/4	146	3 3/4	95	20.5	9.3
1-1/2	40	15 1/4	387	3 3/8	86	3 3/8	86	3 3/4	95	5 3/4	146	4 1/2	114	21.5	9.8
2	50	16	406	3 3/8	86	3 3/8	86	3 3/4	95	5 3/4	146	4 3/4	120.7	23.5	10.7

MODEL 375XLB 1/2" - 1" (STANDARD & METRIC)

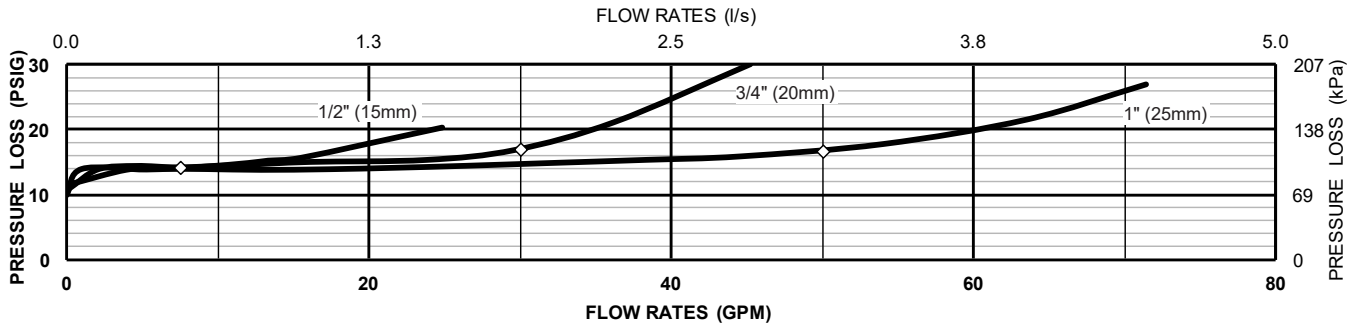

MODEL 375XLB 1-1/4" - 2" (STANDARD & METRIC)

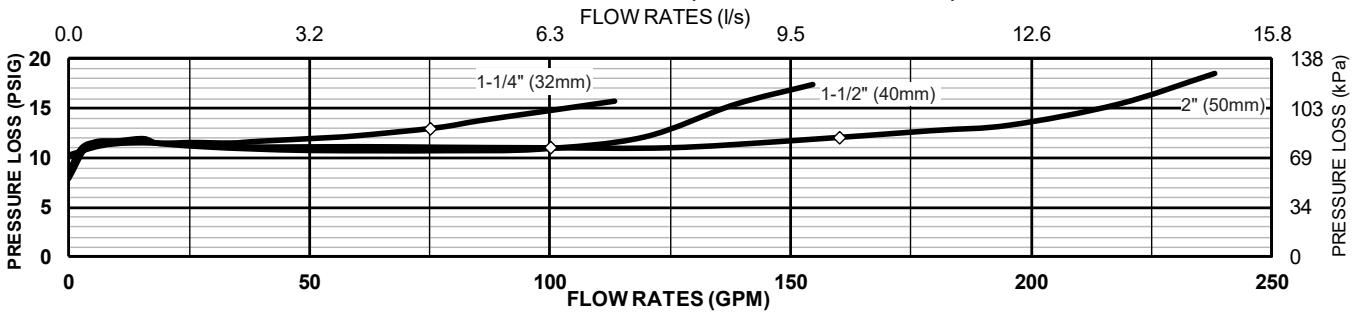

Typical Installation

Local codes shall govern installation requirements. To be installed in accordance with the manufacturers' instructions and the latest edition of the Uniform Plumbing Code. Unless otherwise specified, the assembly shall be mounted at a minimum of 12" (305mm) and a maximum of 30" (762mm) above adequate drains with sufficient side clearance for testing and maintenance. The installation shall be made so that no part of the unit can be submerged.

Relief Valve Discharge Rates

(Worst case condition - If 1st check or relief valve is lodged wide open)

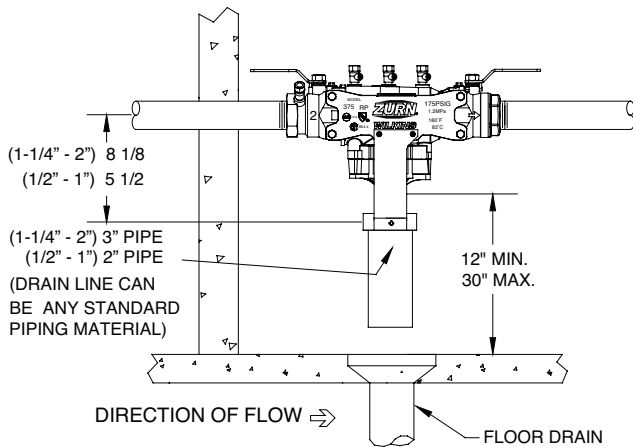
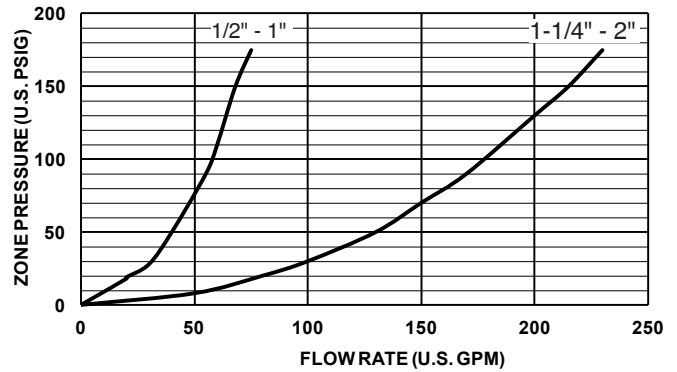

INDOOR INSTALLATION

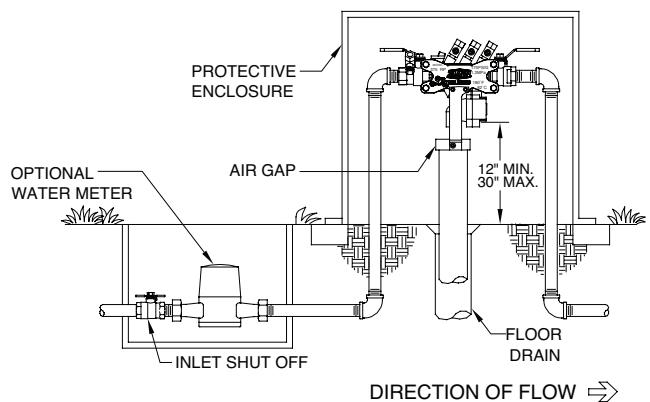

OUTDOOR INSTALLATION

Specifications

The Reduced Pressure Principle Backflow Preventer shall be certified to NSF/ANSI 61, shall be ASSE® Listed 1013, rated to 180°F, and supplied with full port ball valves. The bronze surfaces shall have a black fusion epoxy coating applied. The main body shall be Nylon and the seat disc elastomers shall be silicone. If installed indoors, the installation shall be supplied with an air gap adapter. The Reduced Pressure Principle Backflow Preventer shall be a ZURN WILKINS Model 375XLB.